

Technical data

Taurox®

Type of machine thread tapping machines	Taurox 900
Thread capacity thread cutting (AlMg4.5Mn / 3.3547)	M6 – M22; blind hole 2.0 x D
Thread capacity thread cutting (X6CrNiMoTi17–12–2 / 1.4571 / V4A)	M6 – M18; blind hole 1.5 x D
Torque range adjustable	8.00 – 90.00 Nm
Speed range adjustable	25 – 250 rpm max. 200 rpm from 60 Nm
Modular construction (3-parts)	– spindle unit – operator and display unit – control unit
Operation	Menu driven
LCD Display	4.3" TFT–display, 65536 colors
Spindle / tool holder	quick change holder Size 2
Outreach	201 mm
Travel height adjustment	0 – 425 mm with hand crank
Column Ø / length / swivel range	70 mm / 730 mm / 60°
Machine pedestal (WxDxH)	469 x 296 x 75 mm T-slots DIN 650-12
Dimensions machine (WxDxH)	484 / 469 / 1200 mm
Dimensions control unit (BxTxH)	400 / 210 / 400 mm
Weight with control unit	94 kg
Electric supply / Power input	230 V~ / 1,1 kW
Power input non-operated	< 40 W
Cable length between the modules	3 m (others on request)
Spindle travel / thread depth	90 / 80 mm
Depth accuracy	0.1 mm
Entrance protection class	IP54
Engineer standard	Conforms to CE / EMV
Digital inputs*	3 (24 V)
Digital outputs*	10 (24 V / 3.6 W) short-circuit proof
Finish	RAL 7035 / light grey RAL 5005 / signal blue
Quality evaluations / Error messages	Display with error message Evaluation and audible signal

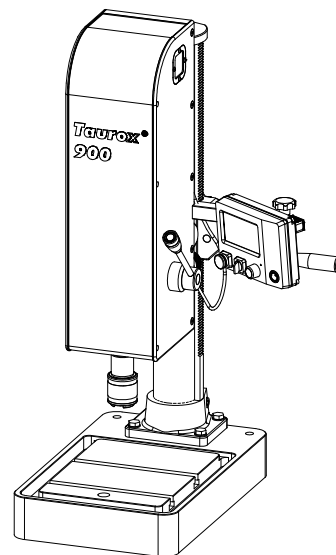

Software / Operation:

- **Languages:** German / English / Spanish (more on request)
- **Operation:** menu-guided via rotary knob and button
- **Display:** 4.3" color TFT–display with graphic quality evaluation
- **Depth unit:** mm / inch
- **Torque monitoring** with actual value display
- Independent of thread type and pitch
- **Process programs:** thread cutting, thread forming, Thread tapping to basic contact with depth tolerance, rethreading with lead monitoring, thread inserts, screw in, thread plug gauge
- **Chip clearance programs**
- **Grade of quality:** blowhole, array of torque, tolerance of depth, tool wear
- **Start program:** Start with start button, Start at workpiece zero point, Start at torque detection (automatic zero point identification with rotating spindle)
All start programs are compatible with feed for spindle feed*.
- **Rotation:** right and left rotation switchable
- **Reversal program:** variable speed 20% - 1000% (max. speed)
- **Parameter database:** 99 parameter data records
- **Counter:** Daily counter, Part counter, Quantity counter, OK / not OK adjustable with subsequent lock
- **Lubrication program:** Cooling lubricant and blow-out programs optimized for minimal quantity lubrication technology*
- **Switching function** for power outputs* for valves such as pneumatic part holder 24 V DC / 3.6 W
- **Digital inputs / outputs*** for automation with pre-assigned functions

*Options / Accessories

Technical data

Taurox®

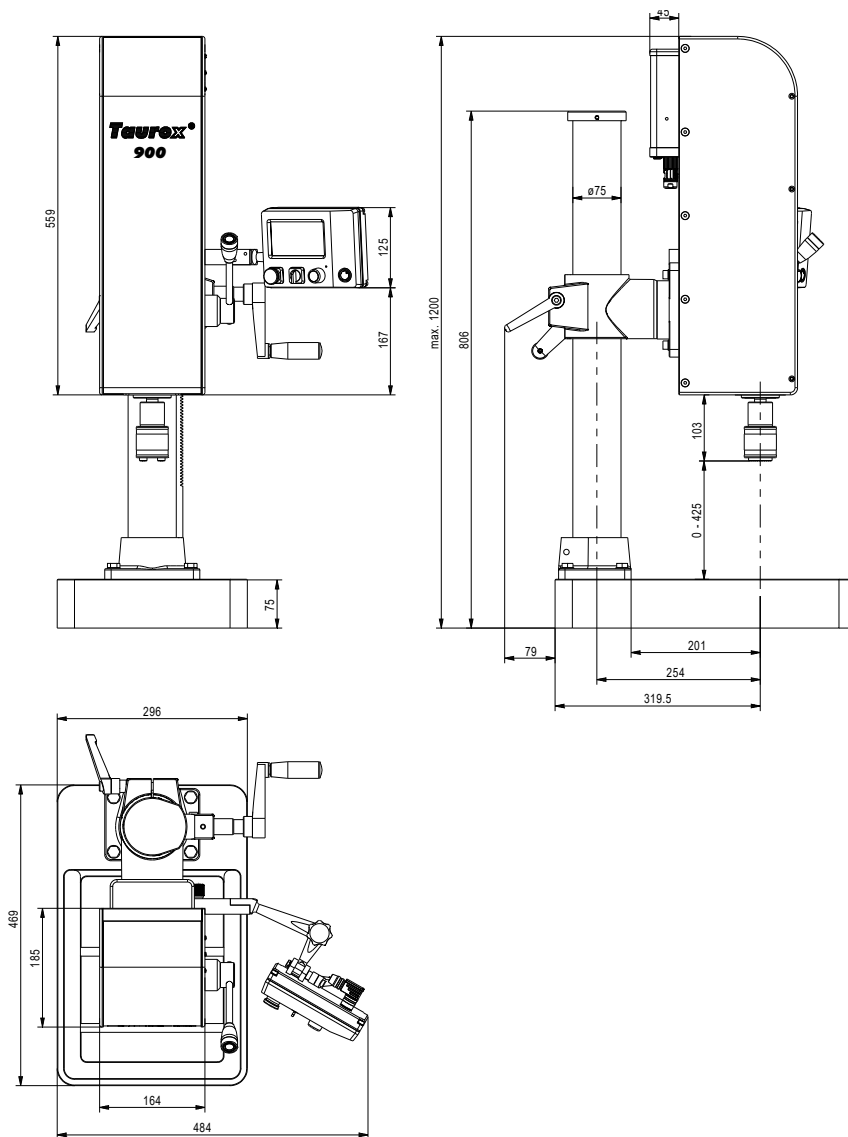

Fig.: View of the thread tapping machine **Taurox 900**

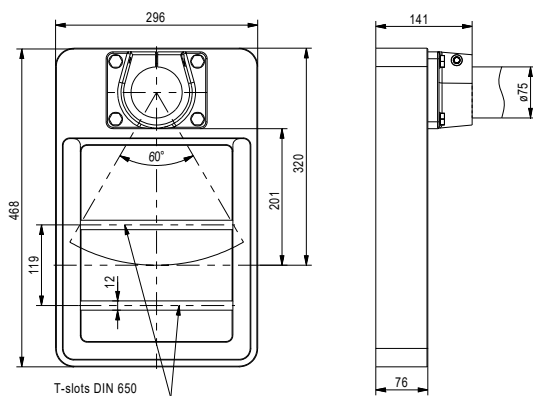

Fig.: View of the machine pedestal **Taurox 900**

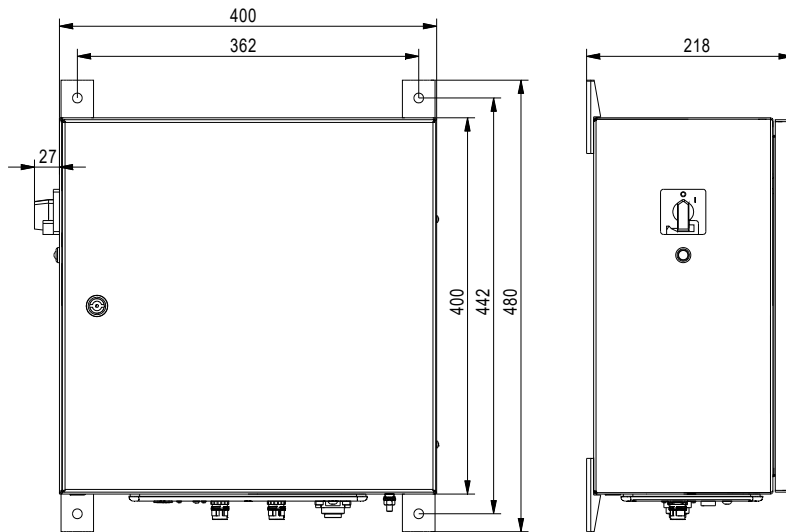

Fig.: View of the control unit **Taurox 900**

Options / Accessories:

- Quick change inserts size 2
- Quick change holder size 1
- Quick change inserts size 1
- Spindle feed system
- Height adjustment (column) with longer travel
- Minimum lubricant unit 2V with lubricant pulse and air pulse
- Minimum lubricant unit 3V with lubricant pulse, air pulse and air cleaning pulse
- Signalbar green, yellow and red for optical quality evaluation in the field of view of processing
- Signal light column green, yellow, red and horn for quality evaluation
- Additional push buttons selection for parameter data base
- Key switch with locking of the user interface
- External operating lock via input 24V DC
- Connection for external emergency stop and motor lock on control unit
- Automation connection via digital inputs and outputs
- Ethernet interface for control unit
- TauroView software for PC to visualize the required torque and optimize the processing parameters
- Customized machine software
- Custom Modbus for automation
- Customized cable lengths